

# Folders

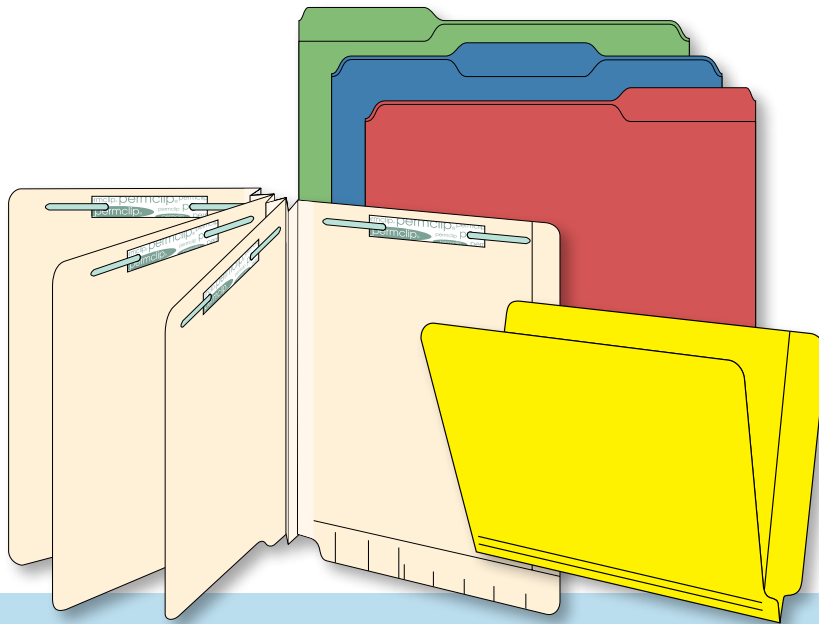

## File Folders

The folder is the most fundamental record management tool for:

- document storage and retrieval
- information management
- document privacy and protection
- presentation

## From Stock to Custom and In-Between

We feature over 300 stock file folders and file pockets in a wide range of sizes and colors to match many of today's most popular systems. From end tab to top tab, manila or color, dividers, and expansion, we're bound to have a solution to your filing needs.

In addition to the great selection of stock file folders, we offer a large collection of value-added folder components such as fasteners, dividers, pockets, and labels.

When a stock or value-added solution doesn't meet your filing or presentation needs, we can customize a folder that satisfies your exact requirements.

## Markets

Our custom filing products and solutions can be tailored to enhance a variety of industry filing applications.

HEALTHCARE



LEGAL



AUTOMOTIVE



INSURANCE / BANKING



# WE'RE CUSTOM FILING EXPERTS

Whether it's a simple printed logo, or a custom crafted classification folder, our expertise and craftsmanship are unmatched.

## CUSTOM OPTIONS INCLUDE

- Custom Construction
- Paper Colors & Weights
- Fasteners
- Printing
- Dividers
- Indexes
- Applied Labels
- Constructed Pockets
- Applied Pockets
- Reinforcing
- Custom Expansion
- Bar Coding
- Consecutive Numbering

TYVEK® GUSSET EXPANSION

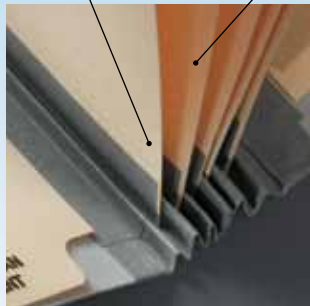

DIVIDERS

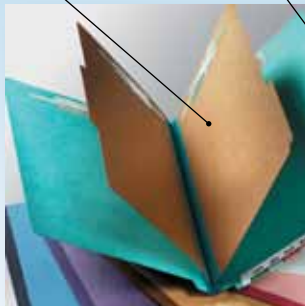

CUSTOM CONSTRUCTION



CONSTRUCTED POCKET



BORDER PRINTING



CONSECUTIVE NUMBERING

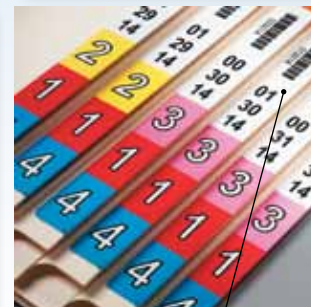

APPLIED STRIP LABEL WITH BAR CODE

PRINTING

# FASTENERS

Factory installed fasteners or clips can be ordered in any position. Please refer to the charts for clip and fastener position numbers.

**permclip®** - Heat bonded to the surface of the folder and nearly impossible to rip from the folder.

**Medi-Clip** - This unique fastener converts any file folder into a ring binder, loose-leaf format.

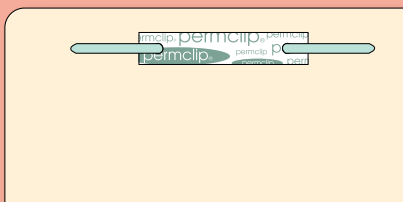

PERMCLIP®

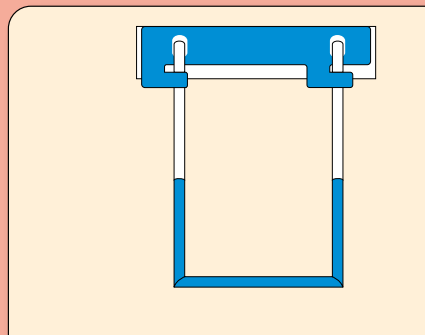

MEDI-CLIP

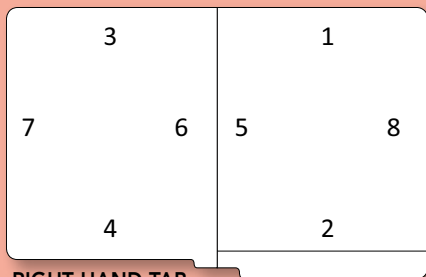

RIGHT HAND TAB

When ordering, state the folder item number, size of the fastener, type of the fastener and the desired position(s).

**Example:** MRS10213 – MRS10 base folder, 2" fastener, position #1 and #3.

Pay special attention to fastener positions when ordering a left-hand tab folder or pocket folders.

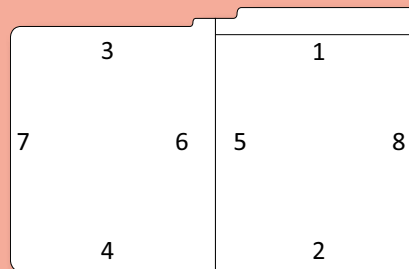

LEFT HAND TAB

# Reinforced End Tab Folders

## MRS10 & MRS20 | CRS10 & CRS15

Comparable to Tab, Smead, Barkley – AS15X & AS25X, TB1103 & TB1123

- Overall Size: 9-1/2" H x 12-1/4" W
- Front Size: 9-1/2" H x 11-3/4" W
- Undercut to: 11-3/8"
- Reinforced end tab
- Tab Length: 8-1/2"
- Scored for 3/4" expansion

Item #	Paper Weight	Fastener Position	Qty per box	Qty per Ctn	Lb / 1,000
MRS10	11pt	None	100	500	90
MRS1021	11pt	1	50	250	95
MRS10213	11pt	1 & 3	50	250	100
MRS20	14pt	None	50	250	110
MRS2021	14pt	1	50	250	115
MRS20213	14pt	1 & 3	50	250	120
MRSD10*	11pt	None	100	500	90
MRSD1021*	11pt	1	50	250	95
MRSD10213*	11pt	1 & 3	50	250	100

\*9" high front panel

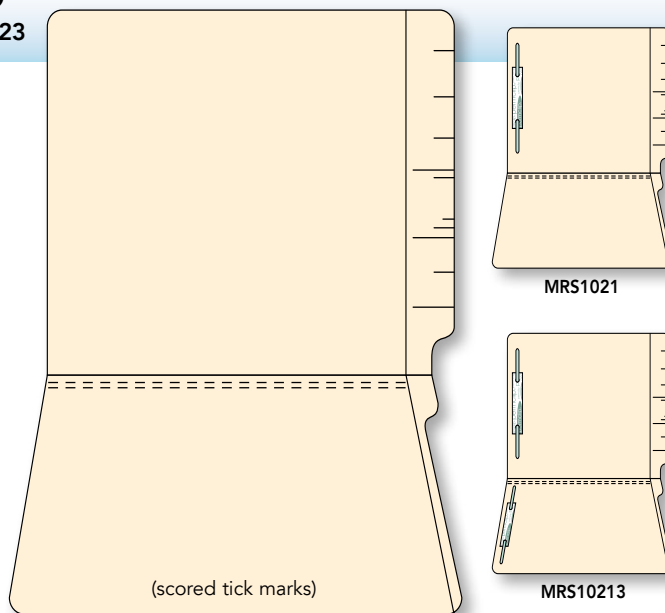

MRS10

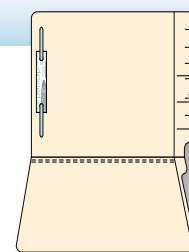

MRS1021

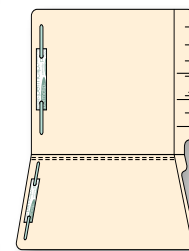

MRS10213

MRS10 also available single ply: AS13X



Item #	Paper Weight	Fastener Position	Qty per box	Qty per Ctn	Lb / 1,000
CRS10** + color	11pt	None	100	500	95
CRS1021 + color	11pt	1	50	250	100
CRS10213 + color	11pt	1 & 3	50	250	105
CRS15*** + color	15pt	None	50	250	110
CRS1521 + color	15pt	1	50	250	115
CRS15213 + color	15pt	1 & 3	50	250	120

\*\*AS15X + color \*\*\*AS25X + color

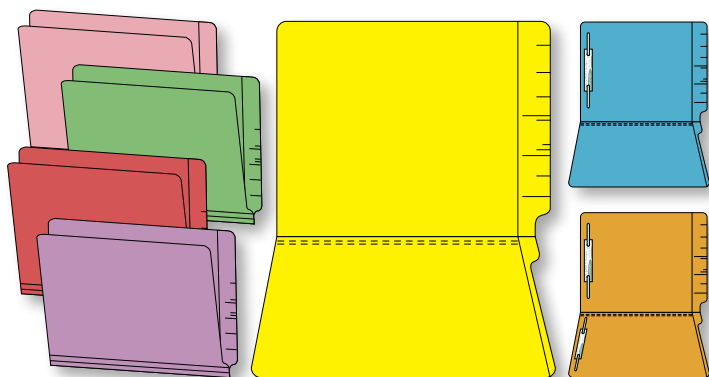

### 18 Available 11pt Colors

red	yellow	pink	green	white	brown	blue	orange	tan
gray	dark orange	dark gray	dark blue	dark green	purple	canary	gldnrd	lavender

### 11 Available 15pt Colors

red	canary	pink	green	white	lavender
gray	dark orange	dark gray	dark blue	gldnrd	

TB1103 & TB1123 only available in manila

## MRS10L & MRS20L

Comparable to Tab, Smead, Barkley – AS35X & AS45X

Overall Size: 9-1/2" H x 15-1/4" W, Front Size: 9-1/2" H x 14-3/4" W, Undercut to: 14-3/8", Tab Length: 8-1/2", Scored for 3/4" expansion

Item #	Paper Weight	Fastener Position	Qty per box	Qty per Ctn	Lb / 1,000
MRS10L	11pt	None	100	500	125
MRS10L21	11pt	1	50	250	130
MRS10L213	11pt	1 & 3	50	250	135
MRS20L	14pt	None	50	250	140
MRS20L21	14pt	1	50	250	145
MRS20L213	14pt	1 & 3	50	250	150

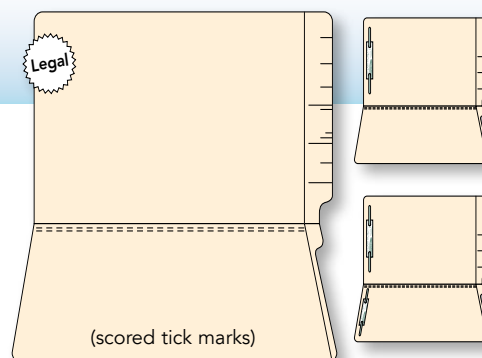

MRS20L also available single ply: AS43X

# FASTENER POSITIONS

## RIGHT HAND TAB FOLDER

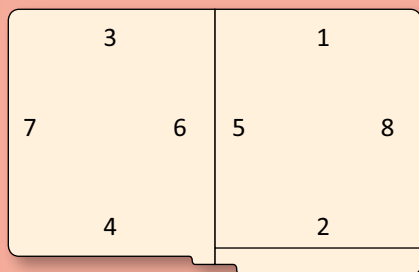

Fasteners or clips can be ordered in any position. Please refer to the charts for clip and fastener position numbers. When ordering, state the folder item number, size of the fastener, type of the fastener and the desired position(s).

**Example: MRS10213 – MRS10 base folder, 2" fastener, position #1 and #3.**

Pay special attention to fastener positions when ordering a left-hand tab folder or pocket folders.

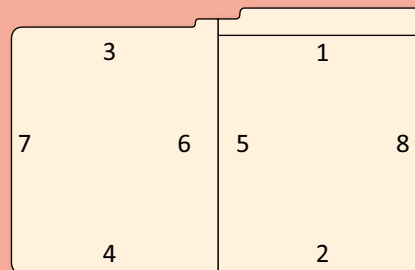

LEFT HAND TAB FOLDER

## JRET11 & JRET14

Comparable to Jeter – JT1050 & JT1241

Overall Size: 9-1/2" H x 12-1/4" W, Front Size: 9-1/2" H x 11-3/4" W, Undercut to: 11-3/8", Tab Length: 8-1/2", Scored for 3/4" expansion

Item #	Paper Weight	Fastener Position	Qty per box	Qty per Ctn	Lb / 1,000
JRET11	11pt	None	100	500	90
JRET1121	11pt	1	50	250	95
JRET11213	11pt	1 & 3	50	250	100
JRET14	14pt	None	50	250	110
JRET1421	14pt	1	50	250	115
JRET14213	14pt	1 & 3	50	250	120

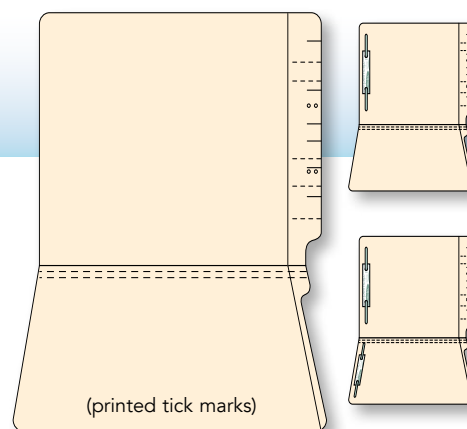

JRET14 also available single ply: JT1231

## MR11 & MR15

Comparable to Jeter – TR1490R, SF29X, & JT2241 (MR15 Matches)

Overall Size: 9-1/2" H x 12-1/4" W, Front Size: 9-1/2" H x 11-3/8" W, Tab Length: 9-3/8", Scored for 3/4" expansion

Item #	Paper Weight	Fastener Position	Qty per box	Qty per Ctn	Lb / 1,000
MR11	11pt	None	100	500	95
MR1121	11pt	1	50	250	100
MR11213	11pt	1 & 3	50	250	105
MR15	14pt	None	50	250	110
MR1521	14pt	1	50	250	115
MR15213	14pt	1 & 3	50	250	120

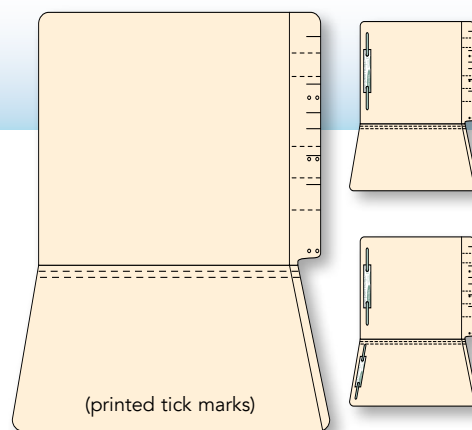

## MAM11 & MAM15

Comparable to Ames – AM1190RTS & AM1590RTS

Overall Size: 9-1/2" H x 12-1/4" W, Front Size: 9-1/2" H x 11-3/8" W, Tab Length: 9", Scored for 1-3/8" expansion, Interlocking reinforced top and end tab

Item #	Paper Weight	Fastener Position	Qty per box	Qty per Ctn	Lb / 1,000
MAM11	11pt	None	100	500	105
MAM1121	11pt	1	50	250	110
MAM11213	11pt	1 & 3	50	250	115
MAM15	14pt	None	50	250	130
MAM1521	14pt	1	50	250	135
MAM15213	14pt	1 & 3	50	250	140

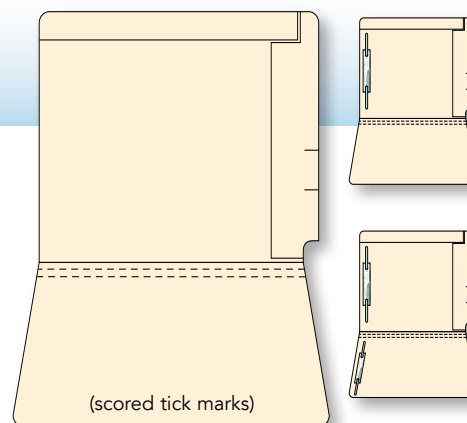

# End Tab Folders

## M11SH

Comparable to Barkley

- Overall Size: 9-1/2" H x 12" W
- Front Size: 9" H x 11-1/4" W
- Tab Length: 8-1/2"
- Scored for 3/4" expansion
- Reinforced top and end tab

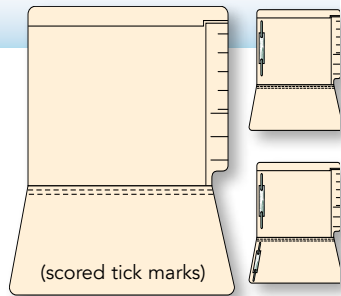

Item #	Paper Weight	Fastener Position	Qty per box	Qty per Ctn	Lb / 1,000
M11SH	11pt	None	100	500	105
M11SH21	11pt	1	50	250	110
M11SH213	11pt	1 & 3	50	250	115

10% post-consumer waste

## M11BC

Border Printed Folder

- Overall Size: 9-1/2" H x 12-1/4" W
- Front: 9-1/2" H x 11-3/4" W
- Undercut to: 11-3/8"
- Tab Length: 8-1/2"
- Scored for 3/4" expansion

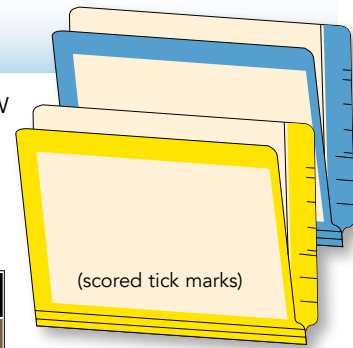

M11BC Colors				
red	yellow	pink	green	brown
gray	orange	tan	blue	violet

Item #	Paper Weight	Fastener Position	Qty per box	Qty per Ctn	Lb / 1,000
M11BC + color	11pt	None	100	500	90
M11BC21 + color	11pt	1	50	250	95
M11BC213 + color	11pt	1 & 3	50	250	100

10% post-consumer waste

## MW15

2" W-Fold Expansion Folder  
Comparable to Ames

- Overall Size: 9-1/2" H x 12-1/4" W
- Front Size: 9-1/2" H x 11-3/8" W
- Tab Length: 9-3/8"
- Scored for 2" W-fold expansion
- Interlocking reinforced top and end tab
- Ships bulk packed, flat

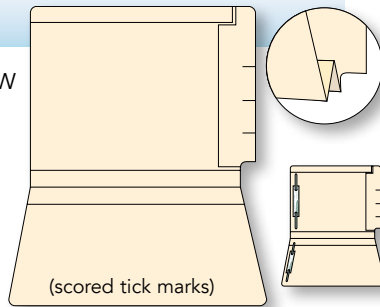

Item #	Paper Weight	Fastener Position	Qty per Ctn	Lb / 1,000
MW15	14pt	None	200	95
MW1521	14pt	1	150	100
MW15213	14pt	1 & 3	150	105

10% post-consumer waste

## AM1590RTS-W

1-3/4" W-Fold Expansion Folder  
Comparable to Ames

- Overall Size: 9-1/2" H x 12-1/4" W
- Front Size: 9-1/2" H x 11-3/8" W
- Tab Length: 9-3/8"
- Scored for 1-3/4" W-fold expansion
- Interlocking reinforced top and end tab
- Ships bulk packed, flat

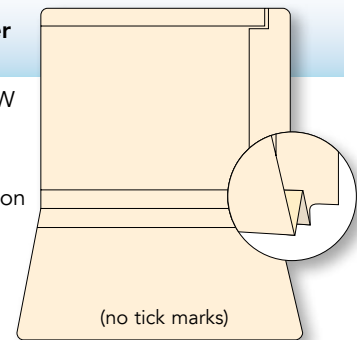

Item #	Paper Weight	Fastener Position	Qty per Ctn	Lb / 1,000
AM1590RTS-W	14pt	None	150	95
AM1590RTS-W21	14pt	1	250	100
AM1590RTS-W213	14pt	1 & 3	250	105

10% post-consumer waste

## AS19X

End Tab Folder

- Overall Size: 9-1/2" H x 12-1/4" W
- Front Size: 9-1/2" H x 11-1/4" W
- Tab Length: 9-3/8"
- Scored for 3/4" expansion
- Reinforced end tab

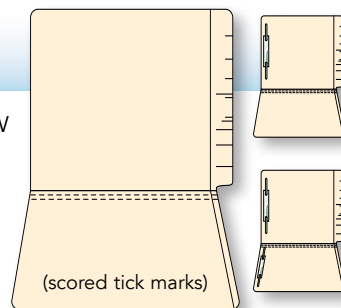

Item #	Paper Weight	Fastener Position	Qty per box	Qty per Ctn	Lb / 1,000
AS19X	11pt	None	100	500	90
AS19X21	11pt	1	50	250	95
AS19X213	11pt	1 & 3	50	250	100

10% post-consumer waste

## AS44X

3/4 Tab Cut End Tab Folder

- Overall Size: 9-1/2" H x 15" W
- Front Size: 9-1/2" H x 14-3/8" W
- Tab Length: 8-1/2"
- Scored for 3/4" expansion
- Reinforced end tab

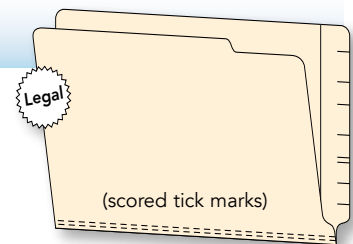

Item #	Paper Weight	Fastener Position	Qty per box	Qty per Ctn	Lb / 1,000
AS44X	14pt	None	50	250	110
AS44X21	14pt	1	50	250	115
AS44X213	14pt	1 & 3	50	250	120

10% post-consumer waste

# MS100 & MS200

Comparable to Tab, Smead, Barkley

- Overall Size: 9-1/2" H x 12-1/4" W
- Front Size: 9-1/2" H x 11-3/4" W
- Undercut to: 11-3/8"
- Tab Length: 8-1/2"
- Scored for 3/4" expansion

10% post-consumer waste

Item #	Paper Weight	Fastener Position	Qty per box	Qty per Ctn	Lb / 1,000
MS100	11pt	None	100	500	75
MS10021	11pt	1	50	250	80
MS100213	11pt	1 & 3	50	250	85
MS200	14pt	None	100	500	95
MS20021	14pt	1	50	250	100
MS200213	14pt	1 & 3	50	250	105

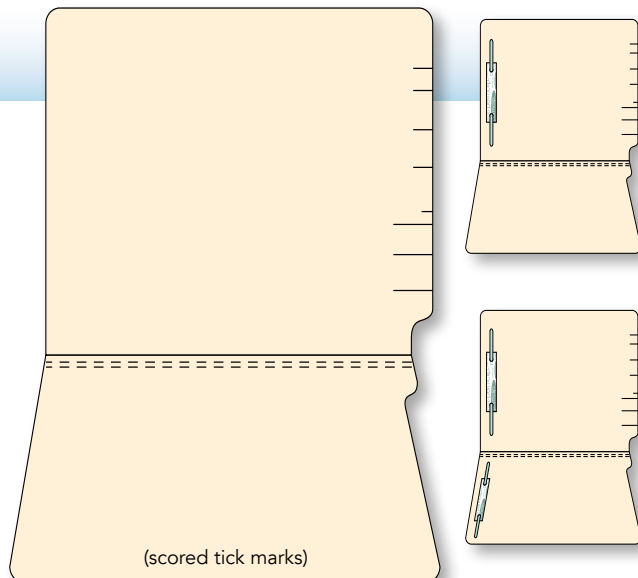

# WF23X & WF73X

2" W-Fold Expansion Folder

- Overall Size: 9-1/2" H x 12-1/4" W
- Front Size: 9-1/2" H x 11-3/8" W
- Tab Length: 9-3/8"
- Scored for 2" W-fold expansion
- Ships bulk packed, flat

Item #	Paper Weight	Fastener Position	Qty per Ctn	Lb / 1,000
WF23X	14pt	None	250	110
WF23X21	14pt	1	250	115
WF23X212	14pt	1 & 3	250	120
WF73X	18pt	None	250	150
WF73X21	18pt	1	250	155
WF73X213	18pt	1 & 3	250	160

14pt - 10% post-consumer waste  
18pt - 30% recycled content

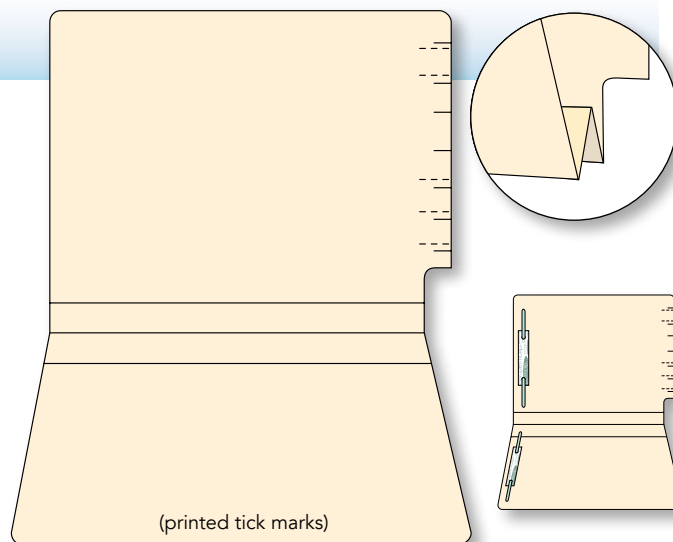

# AS24X

2/3 Tab Cut End Tab Folder

- Overall Size: 9-1/2" H x 12" W
- Front Size: 9-1/2" H x 11-3/8" W
- Undercut to: 11-1/8"
- Tab Length: 7-1/4"
- Scored for 3/4" expansion

10% post-consumer waste

Item #	Paper Weight	Fastener Position	Qty per box	Qty per Ctn	Lb / 1,000
AS24X	14pt	None	100	500	110
AS24X21	14pt	1	50	250	115
AS24X213	14pt	1 & 3	50	250	120

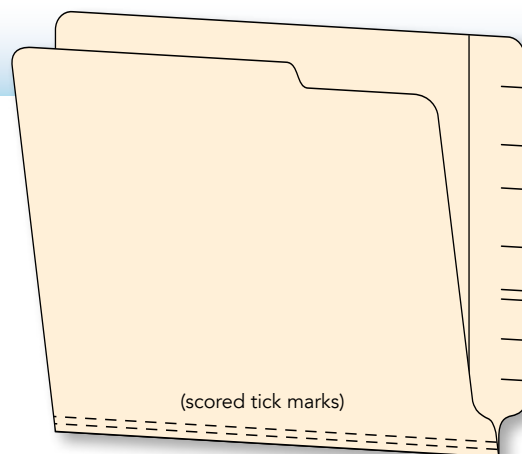

# End Tab Folders

## SF15X & SF25X

Comparable to Smead

- Overall Size: 9-1/2" H x 12-1/4" W
- Front Size: 9-1/2" H x 11-3/4" W
- Undercut to: 11-3/8"
- Tab Length: 8-1/2"
- Scored for 3/4" expansion
- Reinforced end tab

Item #	Paper Weight	Fastener Position	Qty per box	Qty per Ctn	Lb / 1,000
SF15X	11pt	None	100	500	90
SF15X21	11pt	1	50	250	95
SF15X213	11pt	1 & 3	50	250	100
SF25X	14pt	None	50	250	110
SF25X21	14pt	1	50	250	115
SF25X213	14pt	1 & 3	50	250	120

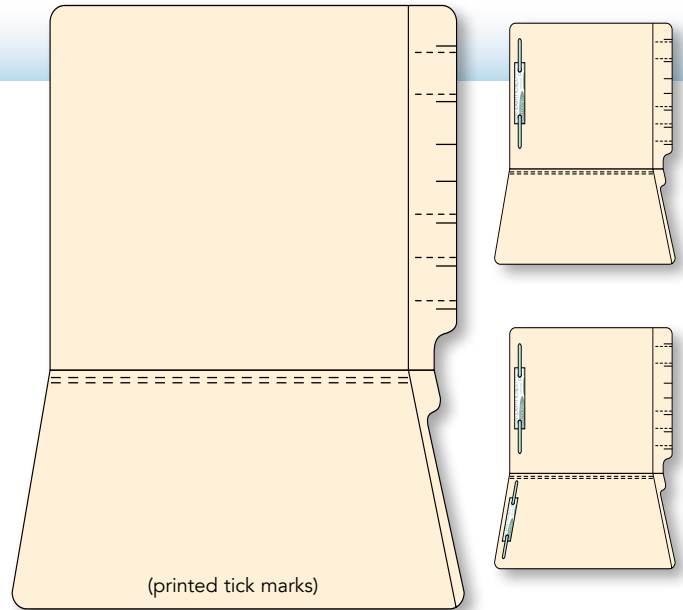

Available single ply: SF23X (14pt) and SF73X (18pt)

Item #	Paper Weight	Fastener Position	Qty per box	Qty per Ctn	Lb / 1,000
SF15X + color	11pt	None	100	500	90
SF15X21 + color	11pt	1	50	250	95
SF15X213 + color	11pt	1 & 3	50	250	100
SF25X + color	14pt	None	50	250	110
SF25X21 + color	14pt	1	50	250	115
SF25X213 + color	14pt	1 & 3	50	250	120

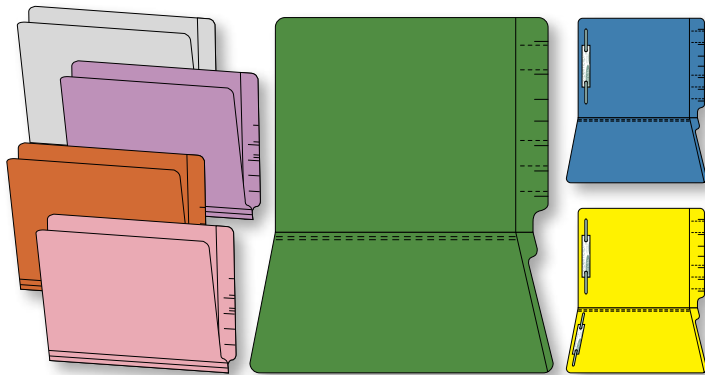

### 10 Available 11pt & 14pt Colors



## SS18 & SS18MMY

18pt Single Ply – AS18X

- Overall Size: 9-1/2" H x 12-1/4" W
- Front Size: 9-1/2" H x 11-3/4" W
- Undercut to: 11-3/8"
- Tab Length: 8-1/2"
- Scored for 3/4" expansion
- Optional Mylar reinforced spine
- Packed 50/box

Item #	Paper Weight	Fastener Position	Lb / 1,000
SS18M	18pt	None	150
SS18M21	18pt	1	155
SS18M213	18pt	1 & 3	160
SS18MMY	18pt	None	150
SS18MMY21	18pt	1	155
SS18MMY213	18pt	1 & 3	160

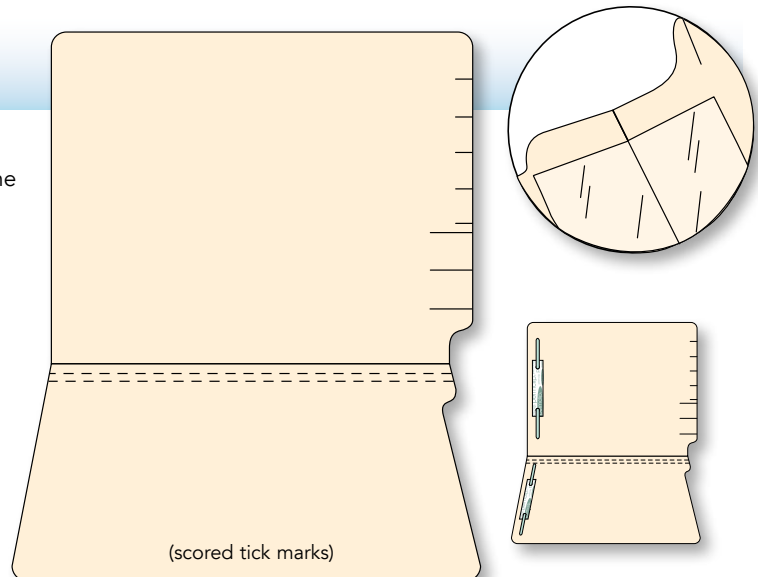

Items MY include Mylar reinforced spine.

# RTE11X & RTE29X

Comparable to Barkley

- Overall Size: 9-1/2" H x 12-1/4" W
- Front Size: 9-1/2" H x 11-3/4" W
- Undercut to: 11-3/8"
- Tab Length: 9"
- Scored for 1-3/8" expansion
- Reinforced top and end tab

Item #	Paper Weight	Fastener Position	Qty per box	Qty per Ctn	Lb / 1,000
RTE11X	11pt	None	100	500	90
RTE11X21	11pt	1	50	250	95
RTE11X213	11pt	1 & 3	50	250	100
RTE29X	14pt	None	50	250	110
RTE29X21	14pt	1	50	250	115
RTE29X213	14pt	1 & 3	50	250	120

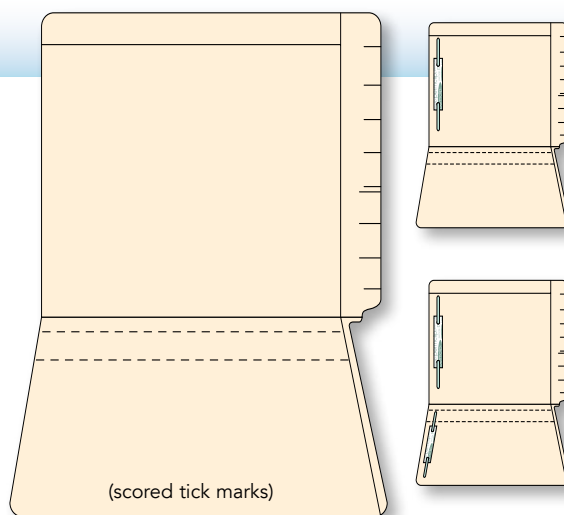

14pt available with 9" drop front: RTE29X-DF

# G8687 & G8688

Comparable to GBS

- Overall Size: 9-1/2" H x 12-1/4" W
- Front Size: 9-1/2" H x 11-3/4" W
- Undercut to: 11-1/2"
- Tab Length: 8-1/2"
- Scored for 3/4" expansion
- Reinforced end tab

Item #	Paper Weight	Fastener Position	Qty per box	Qty per Ctn	Lb / 1,000
G8687	11pt	None	100	500	90
G868721	11pt	1	50	250	95
G8687213	11pt	1 & 3	50	250	100
G8688	14pt	None	50	250	110
G868821	14pt	1	50	250	115
G8688213	14pt	1 & 3	50	250	120

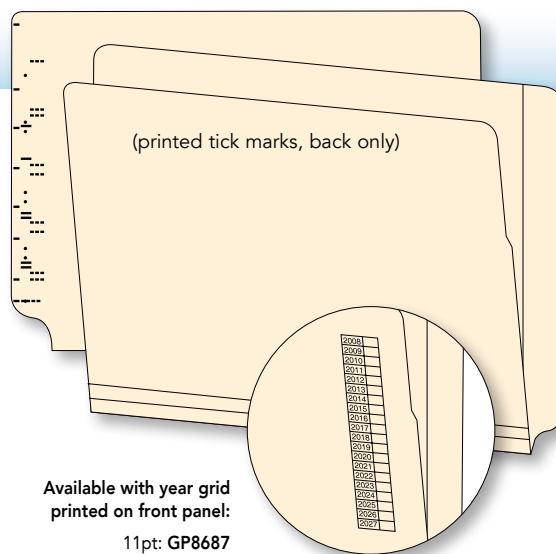

Available with year grid printed on front panel:

11pt: GP8687  
14pt: GP8688

# SG1500

Comparable to Safeguard

- Overall Size: 9-1/2" H x 12-1/4" W
- Front Size: 9-1/2" H x 11-3/8" W
- Tab Length: 9-3/8"
- Scored for 3/4" expansion
- Reinforced end tab

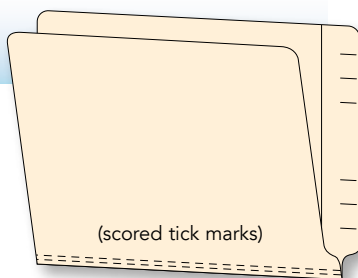

Item #	Paper Weight	Fastener Position	Qty per box	Qty per Ctn	Lb / 1,000
SG1500	15pt	None	50	250	115
SG150021	15pt	1	50	250	120
SG1500213	15pt	1 & 3	50	250	125



# MS15

Comparable to Jeter – F27X & JT2231

- Overall Size: 9-1/2" H x 12-1/4" W
- Front Size: 9-1/2" H x 11-3/8" W
- Tab Length: 9-3/8"
- Scored for 3/4" expansion

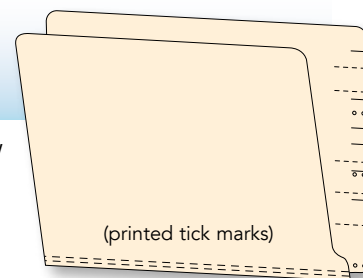

Item #	Paper Weight	Fastener Position	Qty per box	Qty per Ctn	Lb / 1,000
MS15	14pt	None	100	500	95
MS1521	14pt	1	50	250	100
MS15213	14pt	1 & 3	50	250	105



# Top Tab Folders

## M9518, TTC11

Comparable to Smead, Barkley

- Overall Size: 9-1/2" H x 11-3/4" W
- Front Size: 8-7/8" H x 11-3/4" W
- Tab Length: 3-3/4"
- Scored for 3/4" expansion
- Reinforced 1/3 cut top tab



Item #	Paper Weight	Fastener Position	Qty per box	Lb / 1,000
M9518 + tab position	11pt	None	100	90
M951821 + tab position	11pt	1	50	95
M9518213 + tab position	11pt	1 & 3	50	100
TTC11 (33 L, 33 C, 34 R)	11pt	None	100	95
TTC1121 (17 L, 17 C, 16 R)	11pt	1	50	100
TTC11213 (17 L, 17 C, 16 R)	11pt	1 & 3	50	105

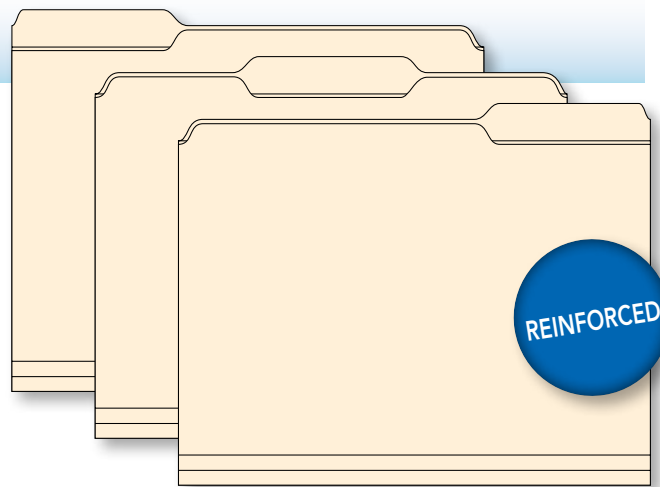

**M9518:** one position (L, C, or R) per box  
**TTC11:** assorted positions (L, C, and R) per box

## SM11

Comparable to Smead

- Overall Size: 9-1/2" H x 11-3/4" W
- Front Size: 9" H x 11-3/4" W
- Full top tab
- Scored for 3/4" expansion
- Full reinforced right end
- 0-9 scale printed in two locations, top & right side on outside back panel

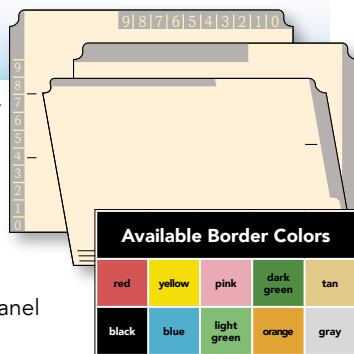

Available Border Colors				
red	yellow	pink	dark green	tan
black	blue	light green	orange	gray

Item #	Paper Weight	Fastener Position	Qty per box	Lb / 1,000
SM11 + color	11pt	None	100	90
SM1121 + color	11pt	1	50	95
SM11213 + color	11pt	1 & 3	50	100



## M11TT

- Overall Size: 9-15/16" H x 11-3/4" W
- Front Size: 8-7/8" H x 11-3/4" H
- Tab Length: 8"
- Scored for 3/4" expansion
- Reinforced top tab

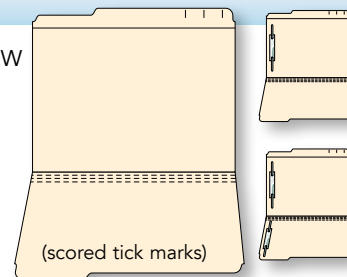

Item #	Paper Weight	Fastener Position	Qty per box	Qty per Ctn	Lb / 1,000
M11TT	11pt	None	100	500	90
M11TT21	11pt	1	50	250	95
M11TT213	11pt	1 & 3	50	250	100



## MR50, 420R

Comparable to Smead, Barkley

- Overall Size: 9-1/2" H x 11-3/4" W
- Front Size: 8-7/8" H x 11-3/4" W
- Tab Length: 11-3/4"
- Scored for 3/4" expansion
- Straight cut reinforced top tab
- Also available single ply: 420



Item #	Paper Weight	Fastener Position	Qty per box	Qty per Ctn	Lb / 1,000
MR50	11pt	None	100	500	90
MR5021	11pt	1	50	250	95
MR50213	11pt	1 & 3	50	250	100



## 423

Comparable to Smead, Barkley

- Overall Size: 9-1/2" H x 11-3/4" W
- Front Size: 8-7/8" H x 11-3/4" W
- Tab Length: 3-3/4"
- 4 scores for 3/4" expansion
- Single ply 1/3 cut top tab
- One position (1, 2, or 3) per box

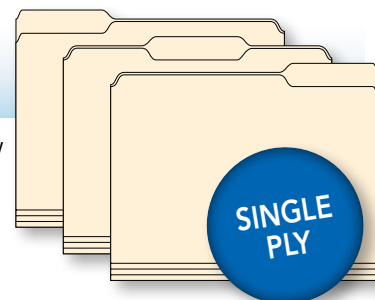

Item #	Paper Weight	Fastener Position	Qty per box	Qty per Ctn	Lb / 1,000
423-1 (L)	11pt	None	100	500	75
423-2 (C)	11pt	None	100	500	75
423-3 (R)	11pt	None	100	500	75
423-(L, C, R)21	11pt	1	50	250	80
423-(L, C, R)213	11pt	1 & 3	50	250	85



# 520 & 620

- Overall Size: 9-1/2" H x 14-3/4" W
- Front Size: 8-7/8" H x 14-3/4" W
- Full top tab
- 4 scores for 3/4" expansion
- Single ply

Item #	Paper Weight	Fastener Position	Qty per box	Qty per Ctn	Lb / 1,000
520	11pt	None	100	500	120
52021	11pt	1	50	250	125
520213	11pt	1 & 3	50	250	130
620	14pt	None	50	250	135
62021	14pt	1	50	250	140
620213	14pt	1 & 3	50	250	145

10% post-consumer waste

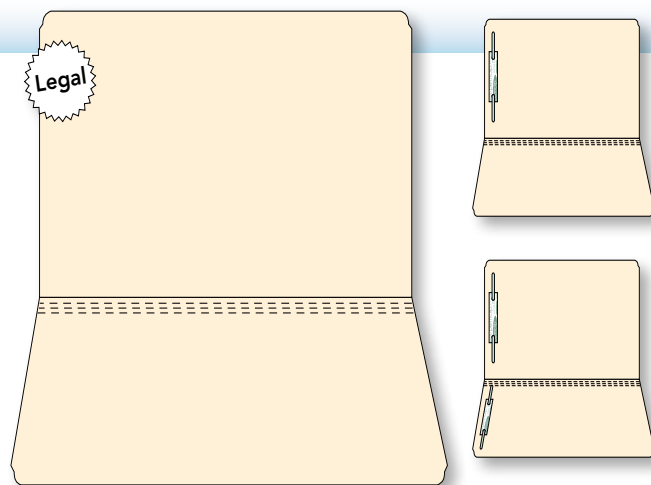

## Folders with Manila Dividers

9-1/2" H x 12-1/4" W

Assembled from stock components, these folders feature an 11pt or 14pt reinforced folder with one or two 11pt manila dividers and permclicps®. (25/box, 125/ctn)

Divider folders allow the contents of each chart to be easily categorized and sub-divided.

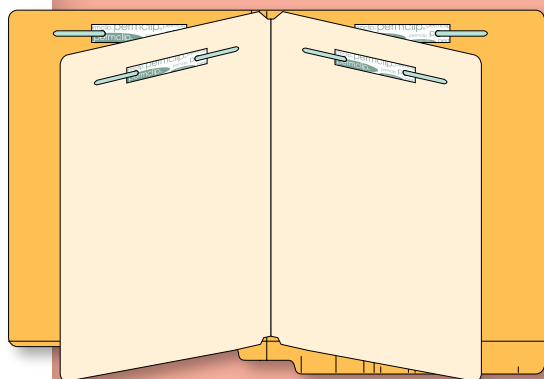

CRS10D2

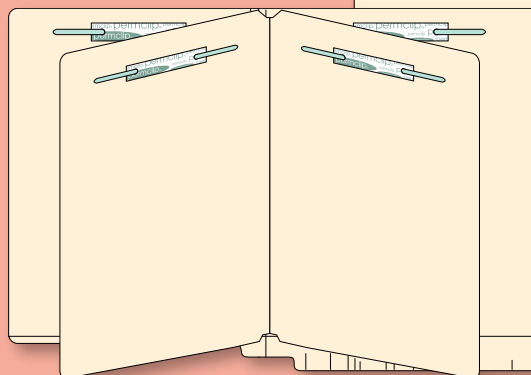

MRS20D2

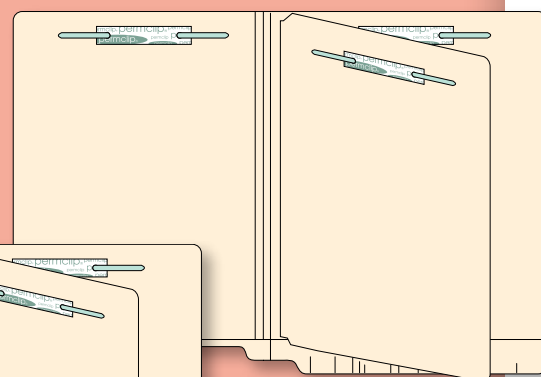

MRS10D1

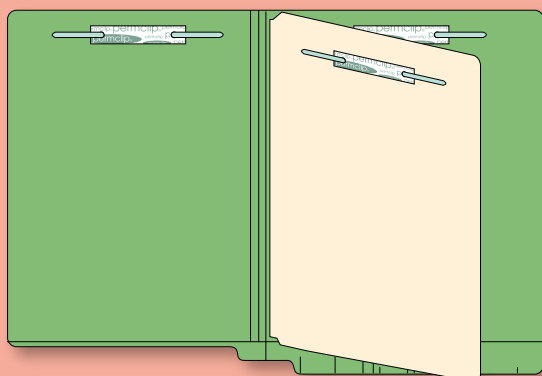

CRS10D1

Specify color when ordering.

red	yellow	pink	green	brown	blue	orange	tan
gray	dark orange	white	dark blue	purple	canary	gldnrd	lavender

Item #	Paper Weight	Fasteners	Qty per box	Lb / 1,000
MRS10D1	11pt	4 total	25	150
MRS10D2	11pt	6 total	25	200
MRS20D1	14pt	4 total	25	195
MRS20D2	14pt	6 total	25	245
CRS10D1 + color	11pt	4 total	25	150
CRS10D2 + color	11pt	6 total	25	200
MRSD10D1*	11pt	4 total	25	150
MRSD10D2*	11pt	6 total	25	200

\* 9" high front panel

10% post-consumer waste

# Pocket Folders

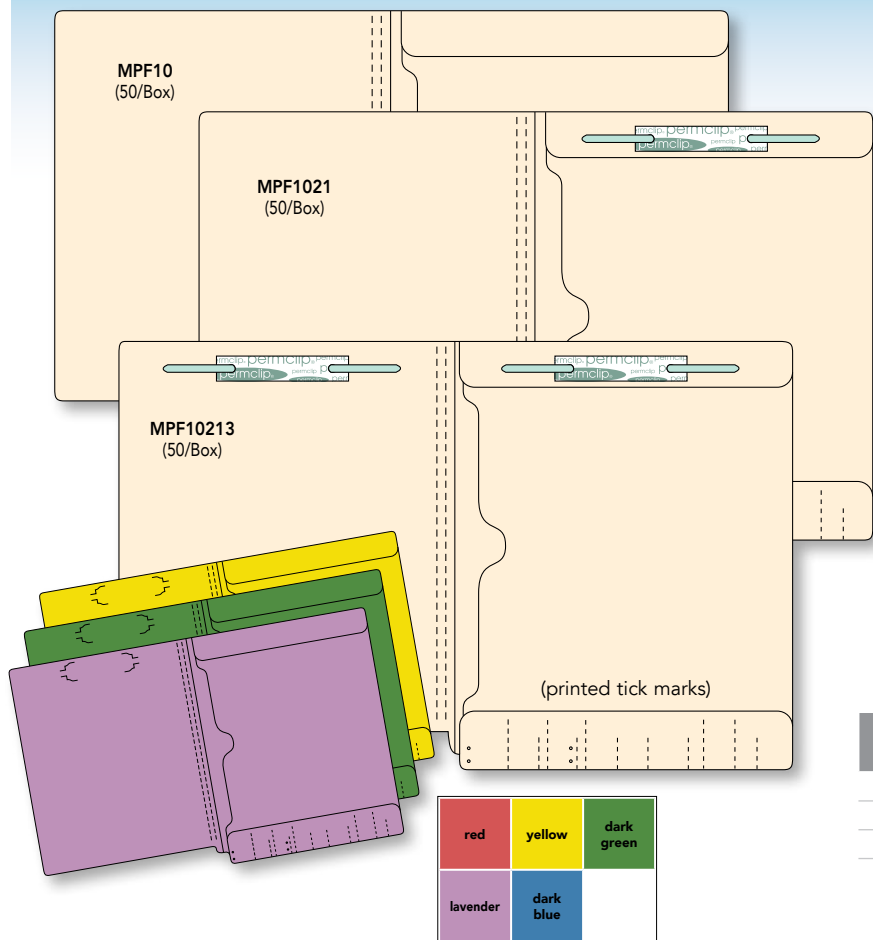

Structurally designed pocket folders and folders with installed pockets have become essential, because of the broad assortment of documents and document sizes being stored today. Choose from a large selection of multi-functional pocket folders to meet your particular needs.

## MPF10

### Comparable to Barkley

Constructed from 11pt manila or colored stock with an integral side seam pocket sealed on three sides. Full size pocket is 9-3/8" H x 12-1/4" W and has printed label placement marks. Overall size is 9-1/2" H x 12-1/4" W.

Item #	Paper Weight	Fastener Position	Qty per box	Qty per Ctn	Lb / 1,000
MPF10	11pt	None	50	250	130
MPF1021	11pt	1	50	250	135
MPF10213	11pt	1 & 3	50	250	140

Specify color when ordering.



## MRSP10 & MRSP14

### Left Hand Single-Pocket Folder

- 11 & 14pt Manila
- 9-1/2" H x 12-1/4" W; pocket 5-3/4" D

## MPFA10

### Full Cut-Corner Pocket Folder

- 9-1/2" H x 12-1/4" W; pocket 9-3/8" H x 11-3/4" W
- 11pt manila stock, double ply tab

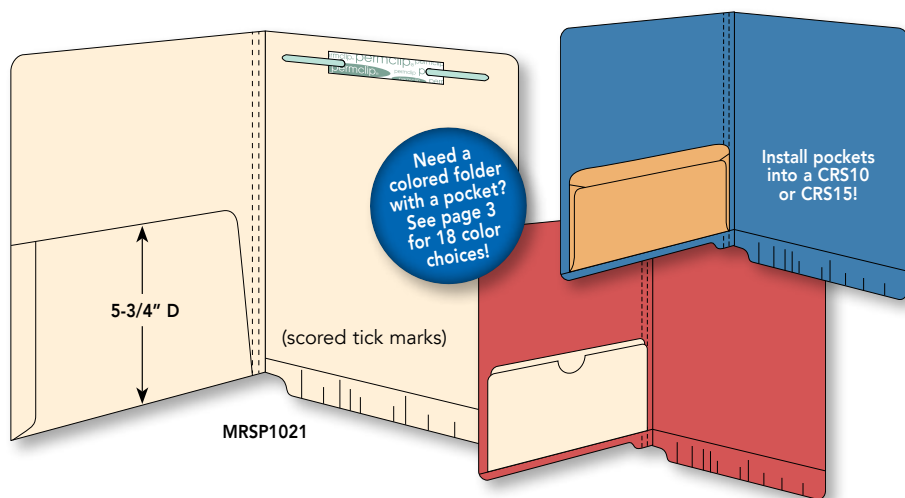

Item #	Paper Weight	Fastener Position	Qty per box	Qty per Ctn	Lb / 1,000
MRSP10	11pt	None	50	250	110
MRSP1021	11pt	1	50	250	115
MRSP14	14pt	None	50	250	150
MRSP1421	14pt	1	50	250	155

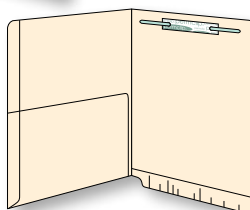

MRSPDF10 or RPF-11 (without clips - not shown)  
MRSPDF1021 (shown)  
available 9" H front, manila only (50/Box)



# Pre-assembled Pocket Folders

9-1/2" H x 12-1/4" W

Base folder is an 11pt manila MRS10.

10% post-consumer waste

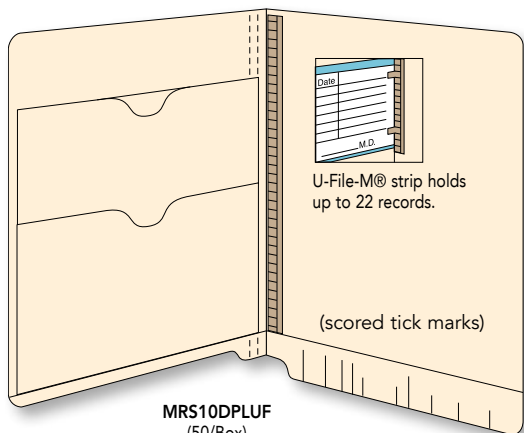

MRS10DPLUF  
(50/Box)

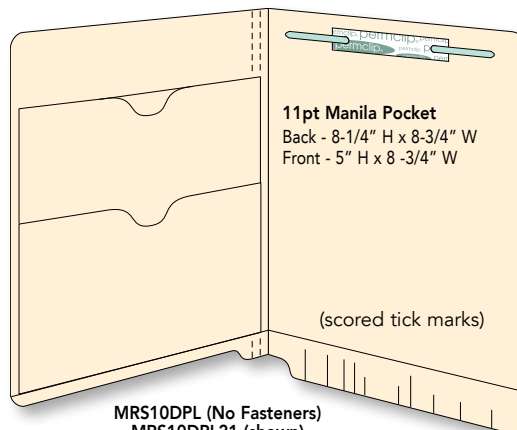

MRS10DPL (No Fasteners)  
MRS10DPL21 (shown)  
(50/Box)

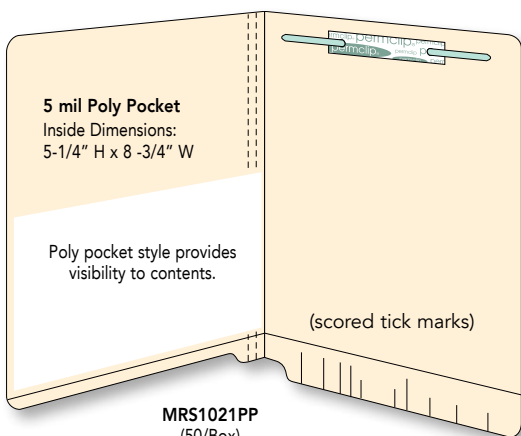

MRS1021PP  
(50/Box)

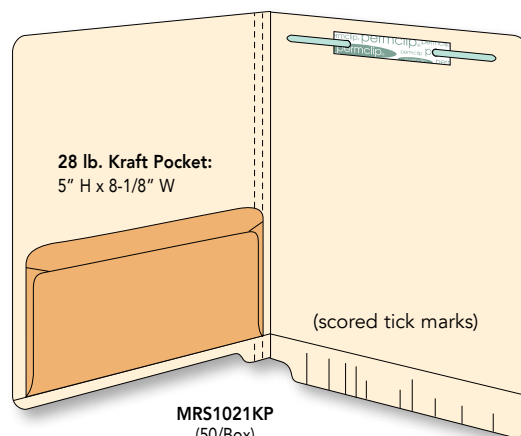

MRS1021KP  
(50/Box)

## ADDED-VALUE

A variety of components – such as printing, fasteners, pockets, dividers, indexes, and labels – can be custom-added to any folder to best meet your document filing and retrieval needs.



PRINTING: PAGE 2

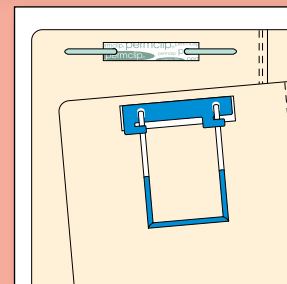

FASTENERS: PAGES 2, 31

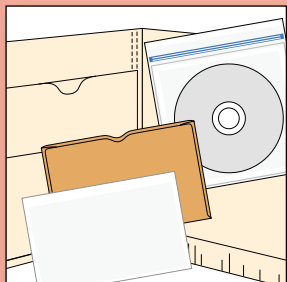

POCKETS: PAGES 37-38

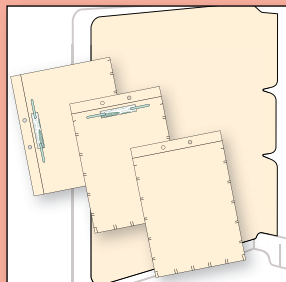

DIVIDERS: PAGE 44

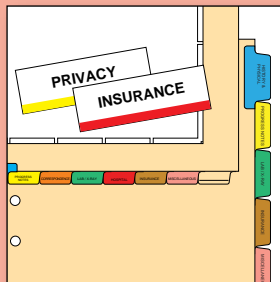

INDEXES: PAGES 40-52



LABELS: PAGES 55-90

# Pocket Folders

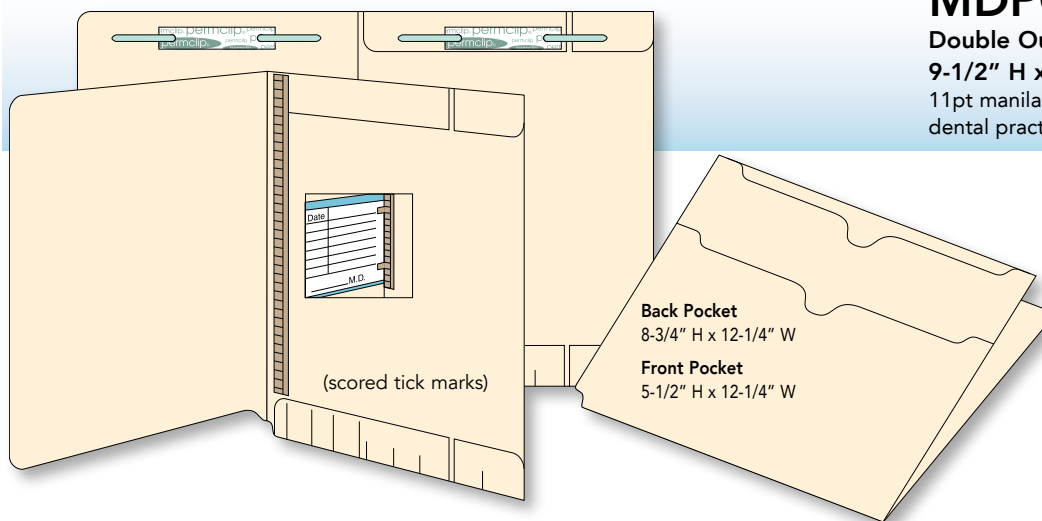

## MDPOUT

### Double Outside-Pocket Folders

9-1/2" H x 12-1/4" W

11pt manila construction; Folder design is perfect for dental practices to hold panorex x-rays, photos, etc.



## MTTPK

### Right Hand Single-Pocket Folder

9-1/2" H x 12-1/4" W; pocket 5-3/4" H x 9" W

11pt manila stock, double ply tab.

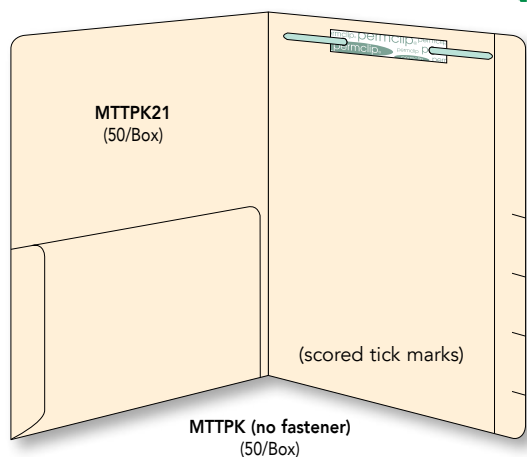

## MPFI14

### Inside Pocket Folder — 9-1/2" H x 12-1/4" W

This one-piece pocket folder is constructed from 14pt manila and features a single inside opening pocket great for storage.

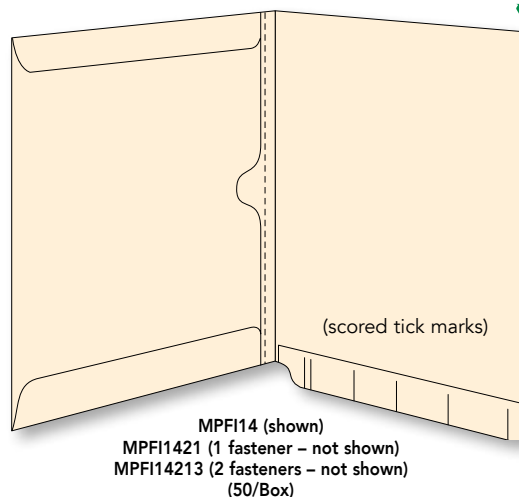

## PF11TRIFOLD

### Comparable to Barkley

9-1/2" H x 12-1/4" W; pocket 9-3/8" H x 12-1/4" W

Constructed from 11pt manila stock with an integral, full size, side seam pocket sealed on three sides.

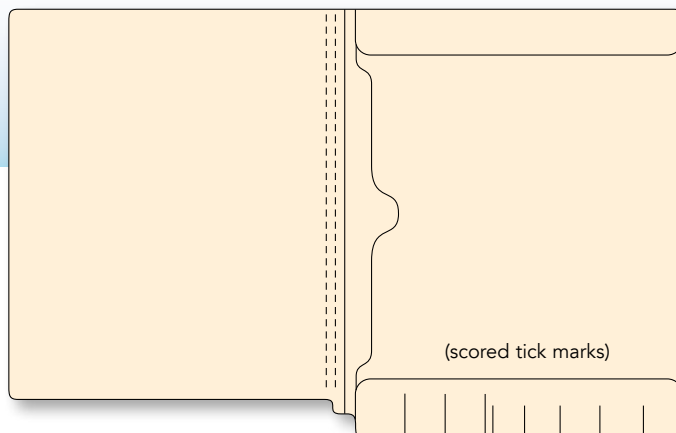

Item #	Paper Weight	Fastener Position	Qty per box	Qty per Ctn	Lb / 1,000
PF11TRIFOLD	11pt	None	50	250	130
PF11TRIFOLD21	11pt	1	50	250	135
PF11TRIFOLD213	11pt	1 & 3	50	250	140



PF11TRIFOLD

# Pocket Folders with Strength & Capacity

## MPFO14213

Full Size 14pt Pocket Folder — 11pt pocket laminated securely inside base folder

- Overall Size: 9-1/2" H x 12-1/4" W
- Pocket Size: 9-3/8" H x 12-1/4" W
- Constructed from 14pt folder (MS15)
- 11pt pocket (FP12) laminated to inside provides maximum durability

Item #	Paper Weight	Fastener Position	Qty per box	Qty per Ctn	Lb / 1,000
MPFO14	14pt	None	50	250	195
MPFO1421	14pt	1	50	250	200
MPFO14213	14pt	1 & 3	50	250	210

10% post-consumer waste

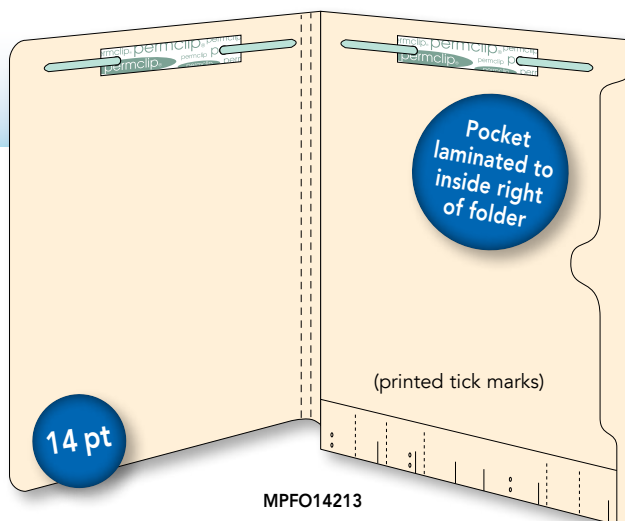

## PF11OUT

Full Size 14pt Pocket Folder — Manila panel glued inside base folder to create a pocket

- Overall Size: 9-1/2" H x 12-1/4" W
- Pocket Size: 9-3/8" H x 12-1/4" W
- Constructed from 14pt folder
- 14pt manila panel glued inside right panel flaps for full side pocket

Item #	Paper Weight	Fastener Position	Qty per box	Qty per Ctn	Lb / 1,000
PF11OUT	14pt	None	50	250	210
PF11OUT21	14pt	1	50	250	215
PF11OUT213	14pt	1 & 3	50	250	220

10% post-consumer waste

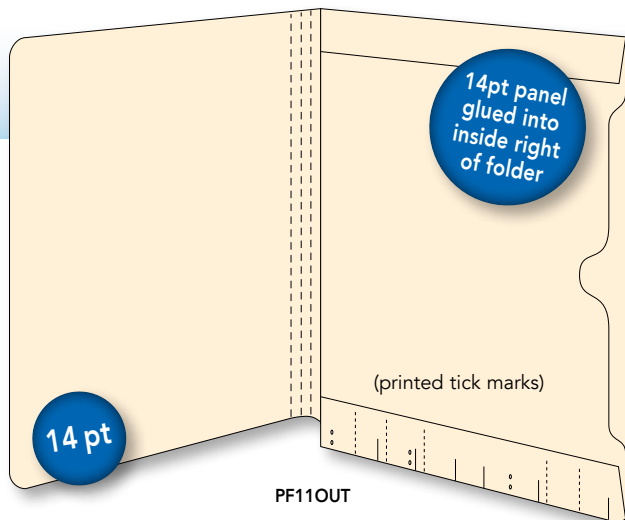

## MPFDP1021

Twin Pocket Folder — Two manila panels glued inside front and back of base folder

- Overall Size: 9-1/2" H x 12-1/2" W
- Left Pocket Size: 8-1/2" H x 11-5/8" W
- Right Pocket Size: 8-1/2" H x 12-1/4" W
- Constructed from 11pt manila
- Two pockets for storing panorex x-rays, photos, etc.

Item #	Paper Weight	Fastener Position	Qty per box	Qty per Ctn	Lb / 1,000
MPFDP10	11pt	None	50	250	150
MPFDP1021	11pt	1	50	250	160
MPFDP10213	11pt	1 & 3	50	250	165

10% post-consumer waste

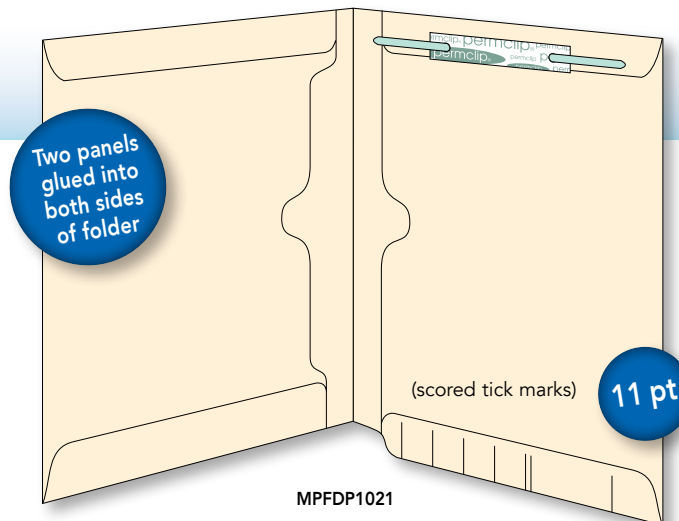

# Divider / Classification Folders

## 14PT Folders with Manila Dividers

9-1/2" H x 12-1/4" W

Construction features 14pt outer folder with double-back 28pt thick dividers, 2" bonded fasteners and a 2" poly reinforced W-fold expansion.

Extra heavy dividers with 2" bonded fasteners provide the necessary rigidity to hold maximum volume of documents. Folders will not sag or bow on the shelf.

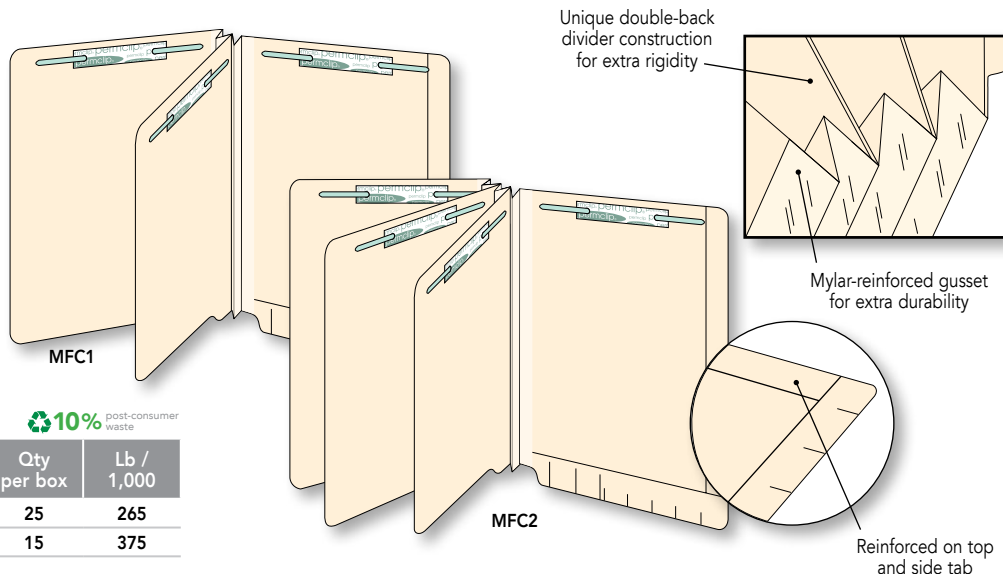

10% post-consumer waste

Item #	Expansion	Fasteners	Qty per box	Lb / 1,000
MFC1	2" W-fold	4 total	25	265
MFC2	3" W-fold	6 total	15	375

## 18PT Folders with Manila Dividers

9-1/2" H x 12-1/4" W

Construction features 18pt single ply folder with Tyvek® gusset. Because of the flexible Tyvek® gusset, these folders will not bulk-up on the shelf and take up valuable space.

Tyvek® spine provides a flexible gusset and long life for active records.

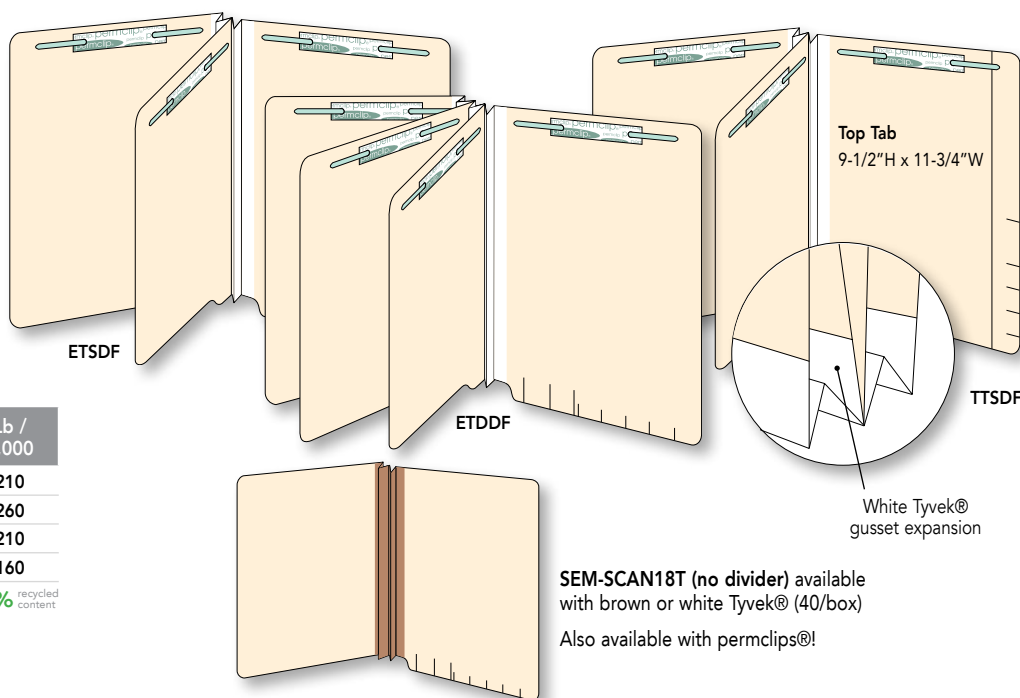

Item #	Expansion	Qty per box	Lb / 1,000
ETADF	1-1/2"	25	210
ETDDF	2"	20	260
TTADF	2"	25	210
SEM-SCAN18T	1-1/2"	40	160

30% recycled content

## Pocket Folders with Manila Dividers

MRSP1421D1 – Base single pocket folder is 14pt thick with an 11pt divider installed in position #5.

DVP113 – Unique construction and features, this 11pt folder has full outside pocket that is 12-1/4" W x 8-1/4" D and will accommodate Panorex x-rays without having to trim them. Scored label placement lines.

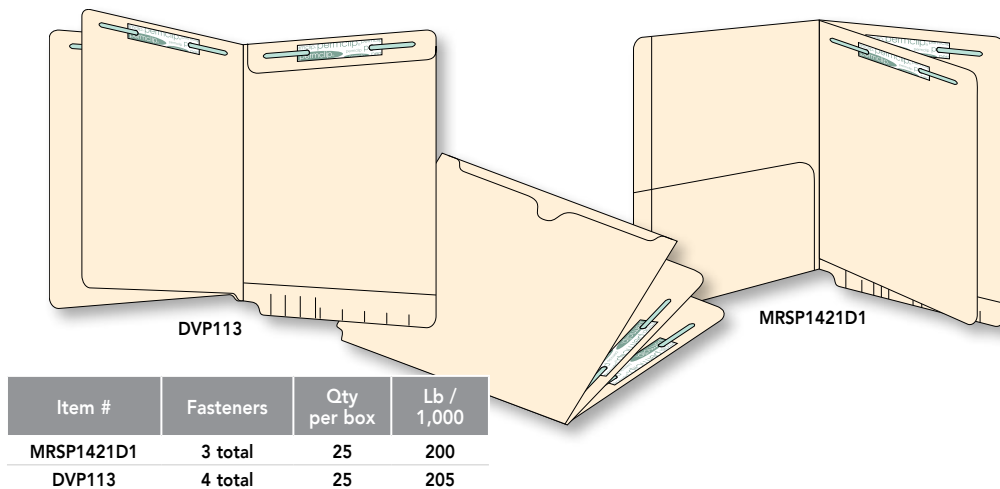

Item #	Fasteners	Qty per box	Lb / 1,000
MRSP1421D1	3 total	25	200
DVP113	4 total	25	205

10% post-consumer waste

## Pressboard

Great for presentation and durability, pressboard folders are manufactured using only the highest quality pressboard and can be customized with a wide range of color, divider, and expansion options.

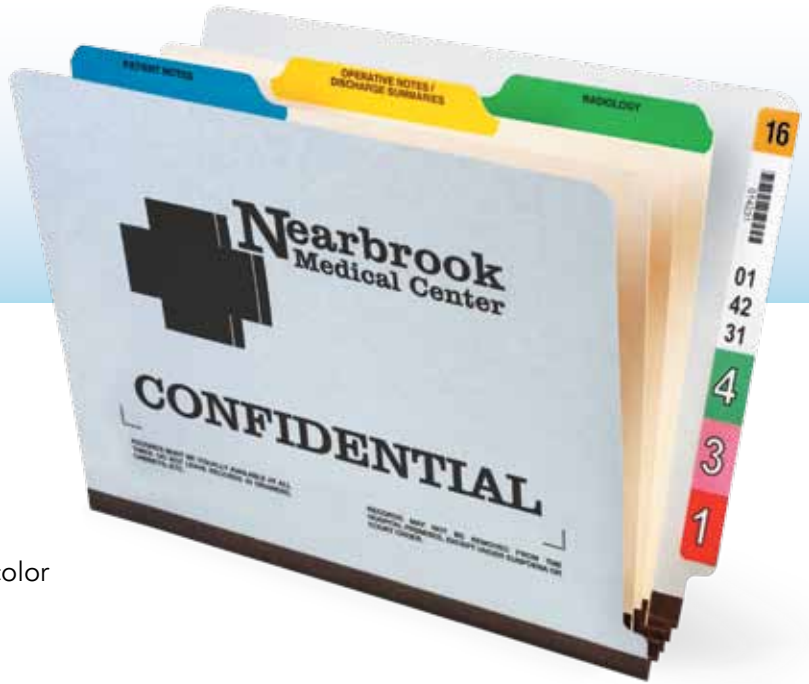

customization...

## Easy as 1, 2, 3

- 1 Select style and size  
(end tab or top tab, letter or legal)
- 2 Choose material (type of pressboard) and color
- 3 Add fasteners, dividers, and more!

## Pressboard

### Type I Genuine Pressboard™ – 20pt

Used for classification folders, guides, and color coding files.



### Type II Guidex® Pressboard – 25pt

One of the most durable materials in the industry.



### Type III Valtex™ Pressboard – 25pt

Economical alternative to Type II Guidex™ Pressboard.

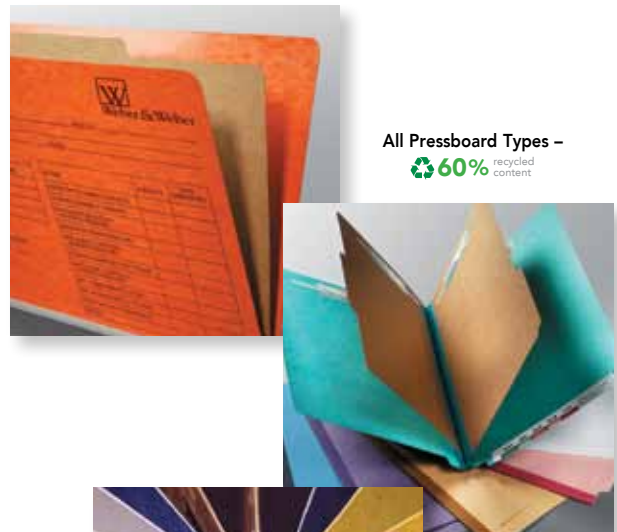

All Pressboard Types –  
60% recycled content



Type I Genuine Pressboard™ and Type II Guidex® Pressboard are registered trademarks of FiberMark



## Tyvek®

Expansions are created with Tyvek®, a strong, virtually tear-proof material. The most common colors are **New Brown** and **Dove Grey**. 22 additional colors available upon request, in minimum quantities.



Tyvek® is a trademark or registered trademark of E.I. du Pont de Nemours and Company.

Catalog color charts are not exact representations of actual products. Contact us for samples or swatches.

# File Pockets

## AC11, AC14, & DJ13X End Tab File Pockets

9-1/2" H x 12-1/4" W – 11pt & 14pt Manila and 11pt Colors  
 Diagonal cut front panel allows easy access to contents. Closed on two sides to secure documents from falling out. Label placement marks on a double ply end tab.



AC11DKG Dark Green	AC11CAN Canary
AC11DKB Dark Blue	AC11D Red

All colors (100/box)

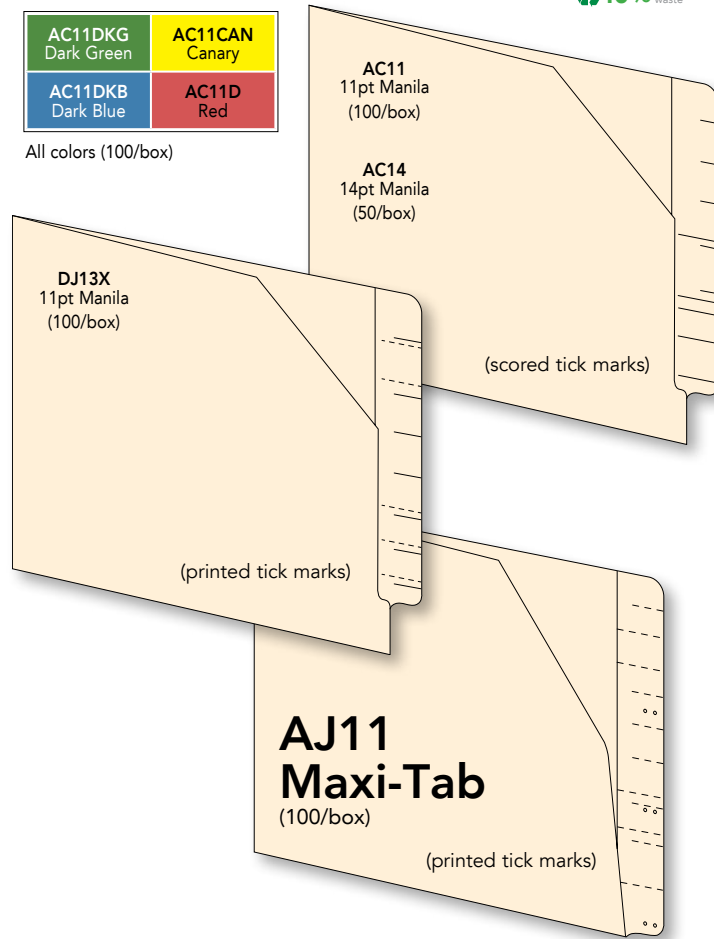

## M11PK 11PT End Tab Pockets

9-1/2" H x 12-1/4" W – Printed Color Border  
 More economical than colored stock, these manila pockets with printed borders have a double ply top and side for extra durability. Pockets have scored tab scores for easy label placement. (100/box)



## DP13E File Pocket

9-3/4" H x 12-5/8" W – 11pt Manila  
 Single ply pocket with top thumb notch to quickly reach documents. Scored at sides and bottom for 5/8" expansion. Ships flat. (100/box)

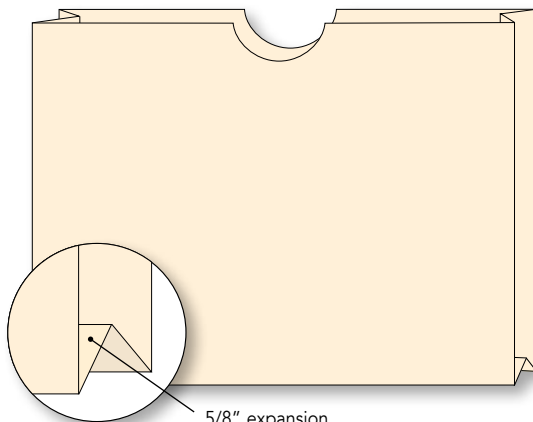

5/8" expansion

## DP12X Top Tab File Pocket

9-1/2" H x 11-3/4" W  
 11pt Manila  
 Recessed thumb notch allows convenient access to documents. Double ply tab provides extra labeling space. (100/box)

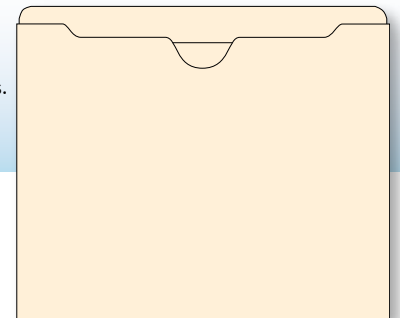

## DP13X Top or End Tab File Pocket

9-1/2" H x 12-1/4" W  
 11pt Manila  
 Double ply top with reinforced side seam and pocket closed on three sides. Scored end tab tick marks. (100/box)

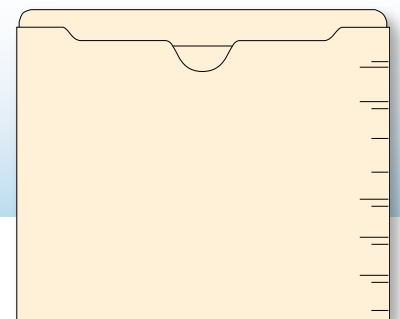

## FP12 End Tab File Pocket

JT14901 – 9-1/2" H x 12-1/4" W – 11pt Manila  
Reinforced side seam construction with single ply top. Pocket is closed on three sides for maximum security and document protection. (100/box)

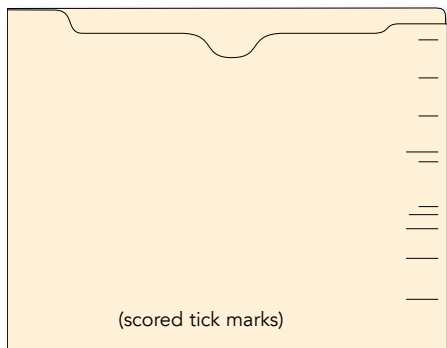

## FP11 Top Tab Pockets

DP12R – 9-1/2" H x 11-3/4" W – 11pt Manila and Colors  
Double ply tab with double recessed thumb notch allows more space for labeling and provides easier access to contents. Perfect for drawer filing when quick color references are required. (100/box)

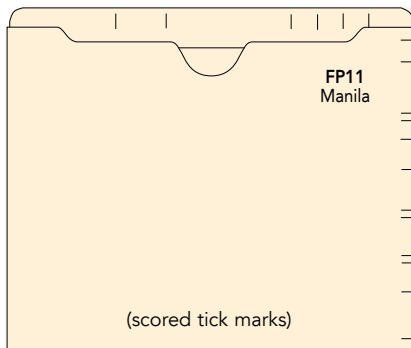

## MXP11



11pt Expansion Pocket  
9-1/2" H x 11-3/4" W - 9" H front  
Double ply top tab with 1-1/2" paper gusset expansion. Ships tucked. (50/box)

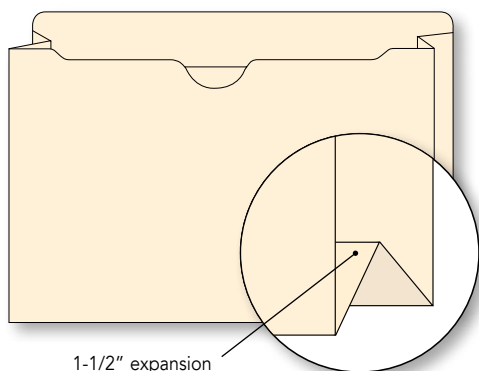

## FPDT12



11PT Manila Pocket  
9-1/2" H x 12-1/4" W  
Double ply top tab with thumbcut front and scored tick marks. (100/box)

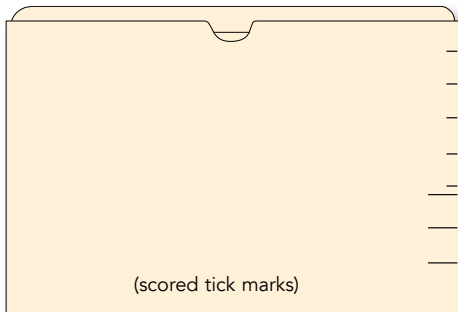

## MJP11



11PT Mini-End Tab  
6" H x 9-1/2" W – Manila  
Single ply end tab designed for optical office applications or small document storage. Closed on 2 sides. (100/box)

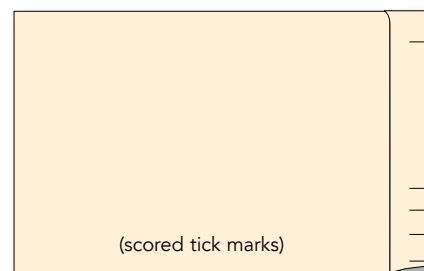

## Economy File Envelopes

28 lb. and 32 lb. – Kraft Colors  
8-3/4" H x 11-3/4" W  
Perfect filing envelopes for lightly used files. Closed on three sides. Front is printed with spaces for name, home and business phone numbers plus addresses. (100/box)

28 lb. – All colors (white stock w/ printed border) except Kraft  
32 lb. – 1071K – Kraft

